

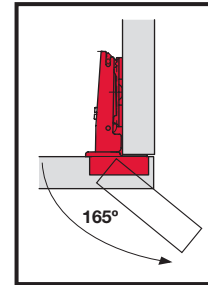

2 PCS

SALICE 165° HINGE
Full Overlay - Clip On

HÄFELE



(k)





Adjusting the Door

Depth adjustment of door with SALICE mounting plates.

With the SALICE mounting plates with quick fixing system, a depth adjustment of the door from -0.5 mm up to $+2.8$ mm is possible via eccentric. It is not necessary to loosen further screws.

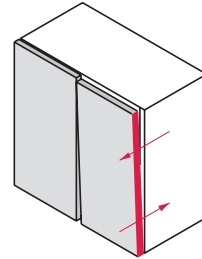
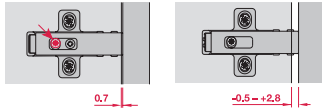

Height adjustment of door with SALICE cruciform mounting plates with slot.

Height adjustment of door of ± 2 mm is possible by loosening the two fixing screws. The slots allow the mounting plates to slide in both directions. Afterwards the screws must be re-tightened.

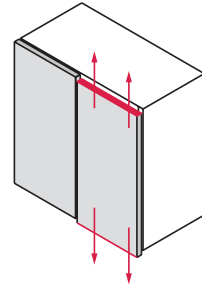
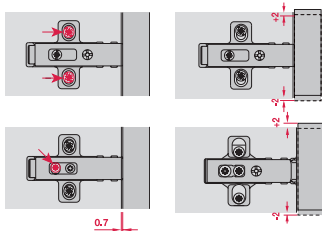

Lateral adjustment of door with SALICE concealed hinges.

The adjusting screw produces the lateral travel of the hinge arm from -1.5 mm up to $+4.5$ mm. This value is reduced to -0.5 mm when using profile door hinges and mini hinges. The door moves with respect to the furniture side without coming apart. There are no further correcting actions required.

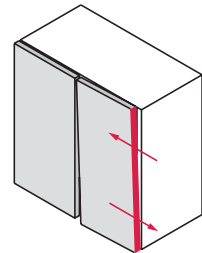
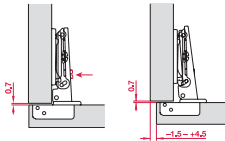



HÄFELE

Drilling Instructions

Hinge Cup (Door)

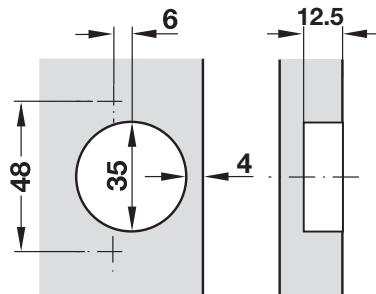

Mounting Instructions

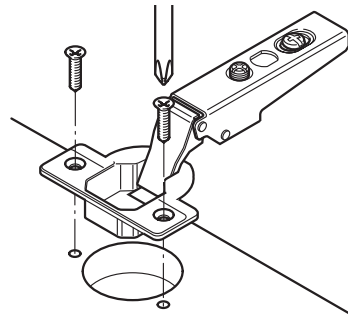

Mount Plate (Cabinet Side)

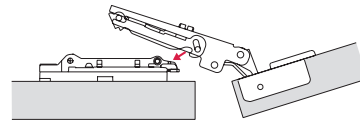
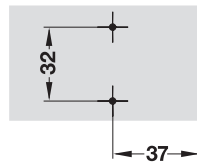
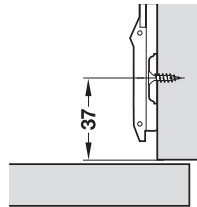

Join the two points marked by an arrow.

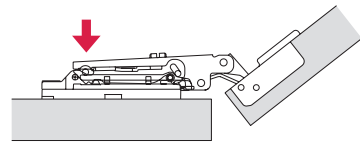

Apply light pressure.



HÄFELE

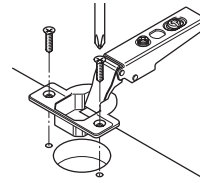
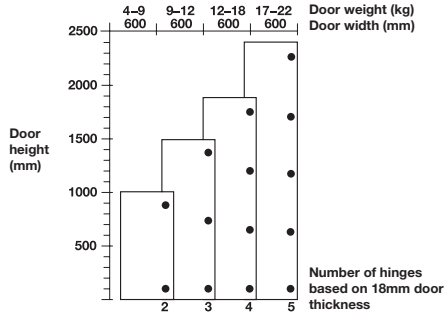

Screw fixing

Cup fixed with screws (countersunk head).

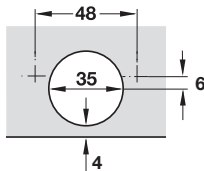

Salice Hinge Drilling Pattern

Tools Required:

- > 35mm Ø Drill Bit & Template Kit
- > 2mm Ø Drill Bit
- > Pencil
- > Power Drill
- > No 2 Pozidrive Screwdriver / Screw Bit

MADE IN ITALY



9 329184 001810

HÄFELE AUSTRALIA PTY. LTD
ARTICLE # 483.02.414

8 MONTEREY RD DANDENONG VIC 3175
730.83.626